

DE-RWA DIRECT ACTING RELIEF VALVE

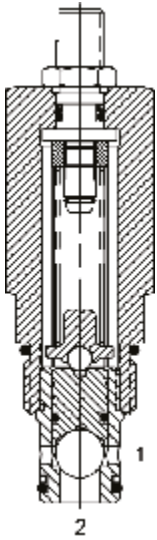

DESCRIPTION

10 size, 7/8-14 thread, "Delta" series, direct acting relief valve.

OPERATION

The DE-RWA blocks flow from (2) to (1) until sufficient pressure is present at (2) to force the poppet to open and allow metered flow from (2) to (1). The cartridge offers smooth transition in response to load changes in common hydraulic circuits.

FEATURES

- Hardened parts for long life.
- Industry common cavity.

HYDRAULIC SYMBOL

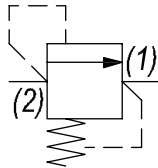

For critical leakage applications consult factory.

PERFORMANCE

Actual Test Data (Cartridge Only)

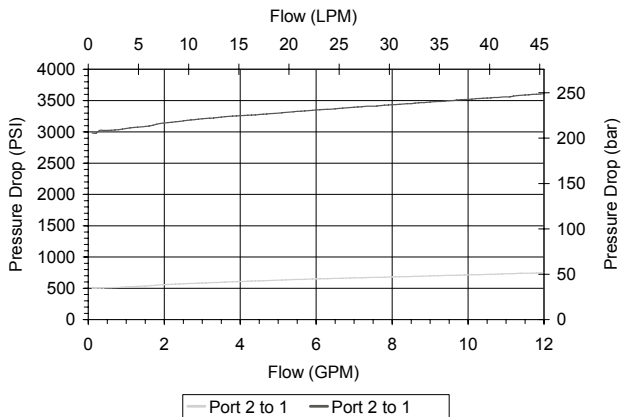

VALVE SPECIFICATIONS

Nominal Flow	8 GPM (30 LPM)
Rated Operating Pressure	4000 PSI (276 bar)
Viscosity Range	36 to 3000 SSU (3 to 647 cSt)
Filtration	ISO 18/16/13
Media Operating Temp. Range	-40° to 250°F (-40° to 120°C)
Weight	.51 lbs (.23 kg)
Operating Fluid Media	General Purpose Hydraulic Fluid
Cartridge Torque Requirements	30 ft-lbs (40.6 Nm)
Cavity	DELTA 2W
Cavity Form Tool (Finishing)	40500000
Seal Kit	21191200

WARNING: the specifications/application data shown in our catalogs and data sheets are intended only as a general guide for the product described (herein). Any specific application should not be undertaken without independent study, evaluation, and testing for suitability.



4484 Boeing Drive Rockford, IL 61109 • USA • Phone +1 (815) 397-6628 • Fax +1 (815) 397-2526
 mail: delta@delta-power.com • www.delta-power.com



Via Malavolti, 36 • 41122 Modena • ITALY • Phone +39 (059) 254895 • Fax +39 (059) 253512
 mail: tecnord@tecnord.com • www.tecnord.com

DIMENSIONS

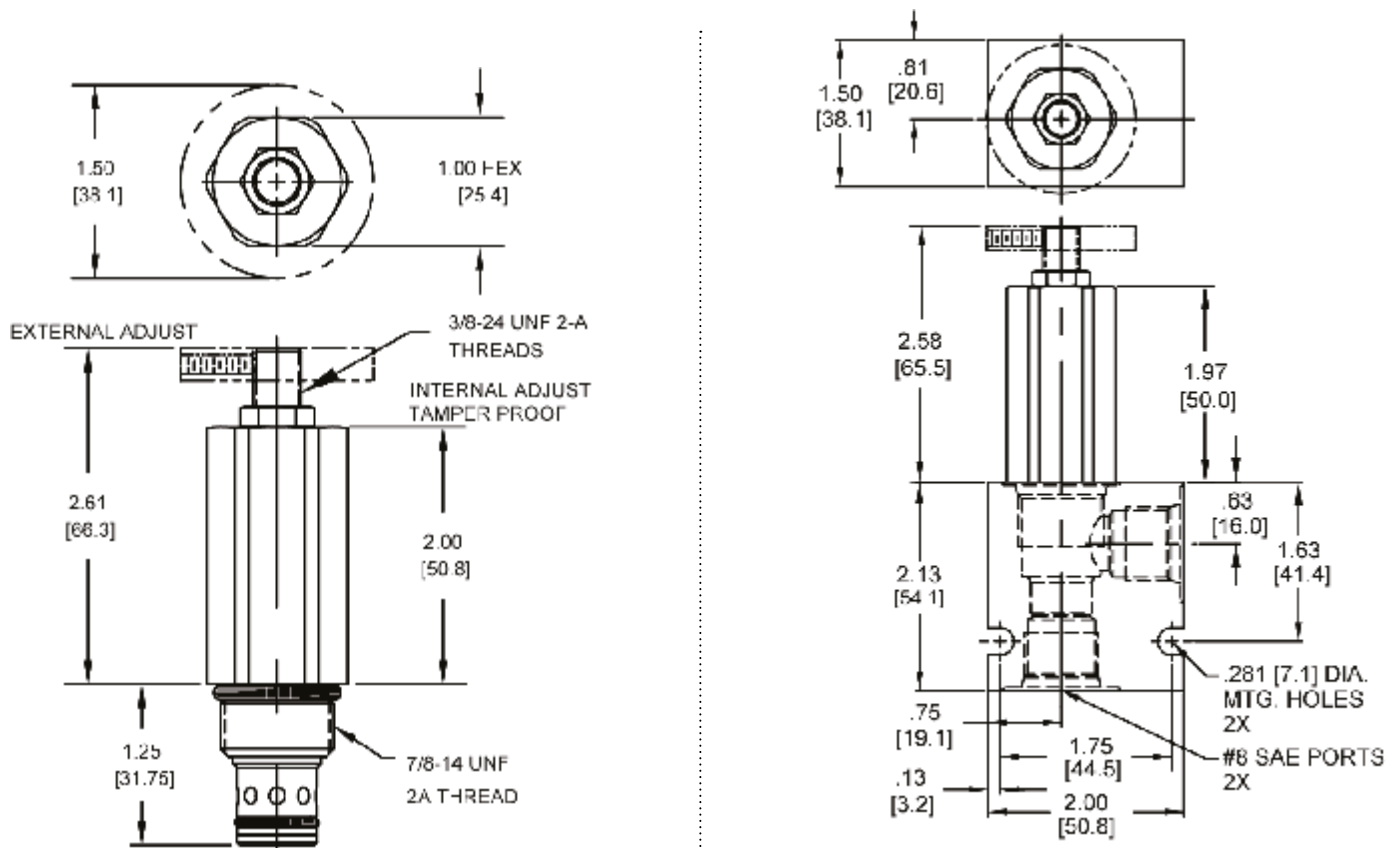

Body Weight: .47 lbs (.21 kg)

ORDERING INFORMATION

DE-RWA - - - -

OPTIONS

- Buna, External Adj. W/Locknut **00**
- Viton, External Adj. W/Locknut **V0**
- Buna, Knob **0K**
- Viton, Knob **VK**
- Buna, Internal Adjust **0I**
- Viton, Internal Adjust **VI**
- Buna, Tamper Proof **0T**
- Viton, Tamper Proof **VT**

BODIES

- Blank Without Body
- N** 3/8" NPTF Ports
- S** #8 SAE Ports

PRESSURE RANGE/SETTING

Ext./Int. Adjustment

- 0500** 100 - 500 PSI
- 3000** 100 - 3000 PSI
- 4000** 3000 - 4000 PSI

Tamper Proof

Fill in 4 Digit Pressure Setting
Example: 0500 - 500 PSI

W7/2017

WARNING: the specifications/application data shown in our catalogs and data sheets are intended only as a general guide for the product described (herein). Any specific application should not be undertaken without independent study, evaluation, and testing for suitability.



4484 Boeing Drive Rockford, IL 61109 • USA • Phone +1 (815) 397-6628 • Fax +1 (815) 397-2526
mail: delta@delta-power.com • www.delta-power.com



Via Malavolti, 36 • 41122 Modena • ITALY • Phone +39 (059) 254895 • Fax +39 (059) 253512
mail: tecnord@tecnord.com • www.tecnord.com