

**HT-RVP PILOT OPERATED RELIEF VALVE**

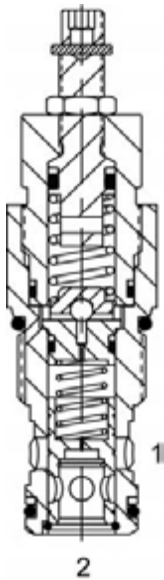

**DESCRIPTION**

12 size, 1 1/16-12 thread, "Tecnord" series, pilot operated relief valve.

**OPERATION**

The HT-RVP blocks flow from (2) to (1) until sufficient pressure is present at (2) to force the pilot stage off its seat, allowing the main stage spool to shift, opening (2) to (1). The cartridge offers smooth transition in response to load changes in common hydraulic circuits.

**FEATURES**

- Hardened parts for long life.
- Industry common cavity.



*Undercut cavity recommended for circuits above 2500 PSI where flows go to 30 GPM.*

**HYDRAULIC SYMBOL**

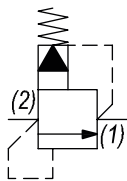

**PERFORMANCE**

Actual Test Data (Cartridge Only)

**VALVE SPECIFICATIONS**

Nominal Flow	20 GPM (76 LPM)
Rated Operating Pressure	5000 PSI (345 bar)
Viscosity Range	36 to 3000 SSU (3 to 647 cSt)
Filtration	ISO 18/16/13
Media Operating Temp. Range	-40° to 250°F (-40° to 120°C)
Weight	1.13 lbs (.51 kg)
Operating Fluid Media	General Purpose Hydraulic Fluid
Cartridge Torque Requirements	70 ft-lbs (95 Nm)
Cavity	TECNORD 2W
Cavity Form Tool (Finishing)	40500032
Seal Kit	21191300

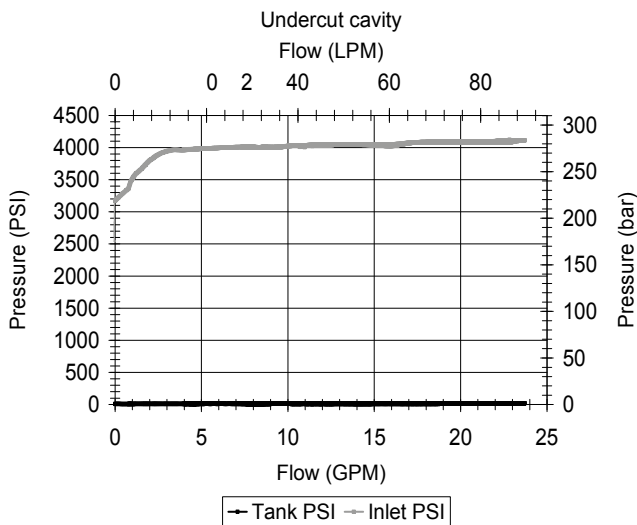
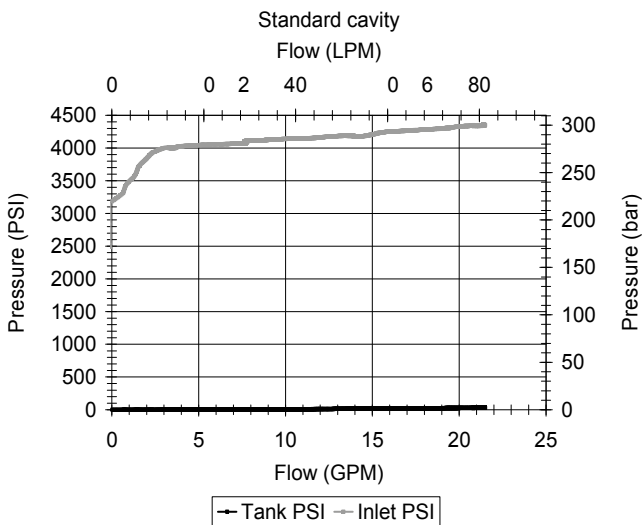

**WARNING:** the specifications/application data shown in our catalogs and data sheets are intended only as a general guide for the product described (herein). Any specific application should not be undertaken without independent study, evaluation, and testing for suitability.



4484 Boeing Drive Rockford, IL 61109 • USA • Phone +1 (815) 397-6628 • Fax +1 (815) 397-2526  
 mail: delta@delta-power.com • www.delta-power.com



Via Malavolti, 36 • 41122 Modena • ITALY • Phone +39 (059) 254895 • Fax +39 (059) 253512  
 mail: tecnord@tecnord.com • www.tecnord.com

**DIMENSIONS**

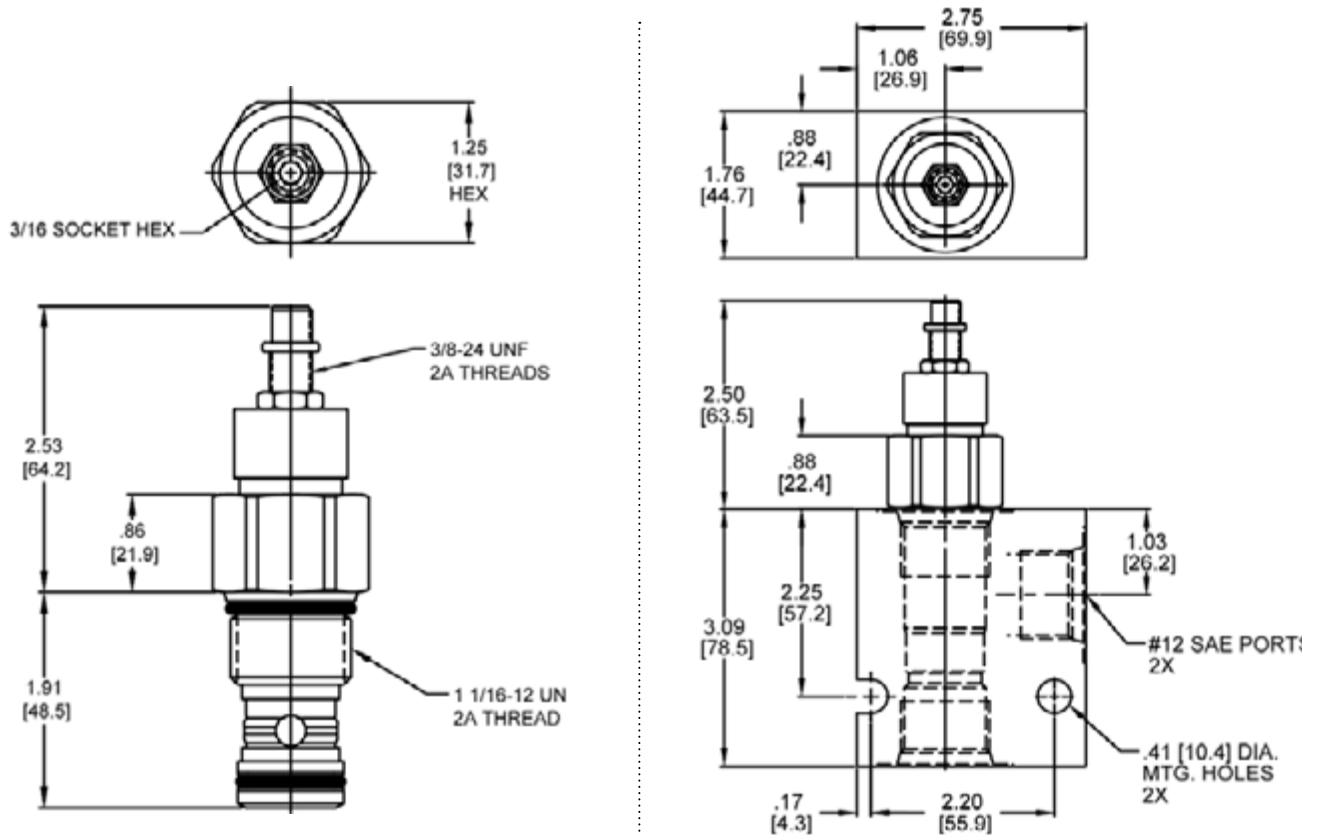

Body Weight: 3.71 lbs (1.68 kg)

**ORDERING INFORMATION**

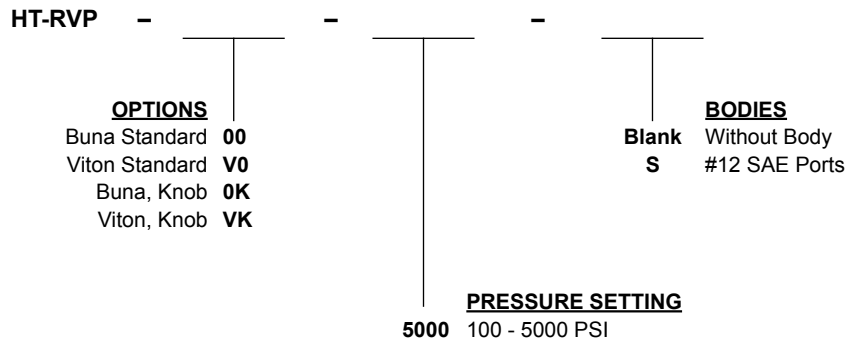

W7/2017

**WARNING:** the specifications/application data shown in our catalogs and data sheets are intended only as a general guide for the product described (herein). Any specific application should not be undertaken without independent study, evaluation, and testing for suitability.



4484 Boeing Drive Rockford, IL 61109 • USA • Phone +1 (815) 397-6628 • Fax +1 (815) 397-2526  
 mail: delta@delta-power.com • www.delta-power.com



Via Malavolti, 36 • 41122 Modena • ITALY • Phone +39 (059) 254895 • Fax +39 (059) 253512  
 mail: tecnord@tecnord.com • www.tecnord.com