

IMMERSION PROOF "L" TYPE "I" COILS

DESCRIPTION

5/8 inch (16 mm) I.D. Immersion Proof Coil.

FEATURES

One piece encapsulated design that is:

- Weatherproof
- Immersion proof
- Thermal shock / dunk tested
- No external metal shel

COIL SPECIFICATION

Wattage	26 Watts Nominal
Duty Rating	Continuous Duty ±10% rated voltage at 120°F (49°C) ambient
Min Current for Actuation	80% of rated current at room temperature
Magnet Wire Class	H or Better for all voltages
Temperature Range	-40° to 392°F (-40° to 200°C)
Encapsulation Material	Thermo-Plastic, resistant to moisture, caustic solutions, fungus, and vibrations

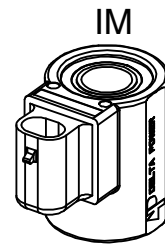
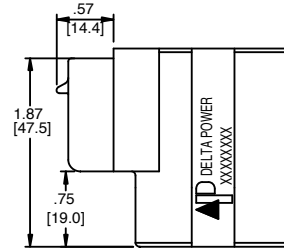
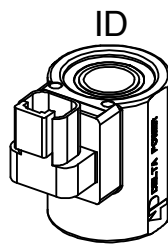
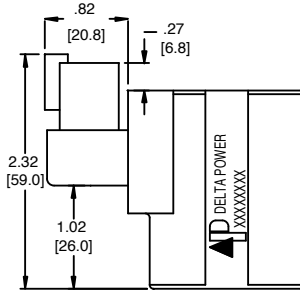
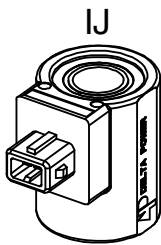
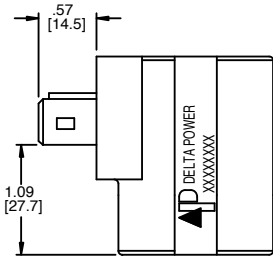
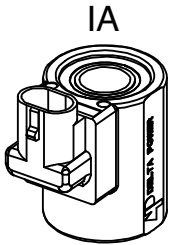
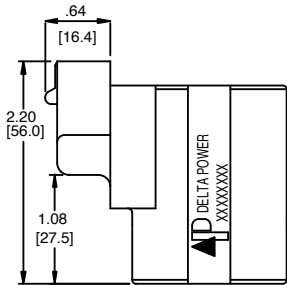
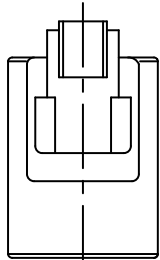
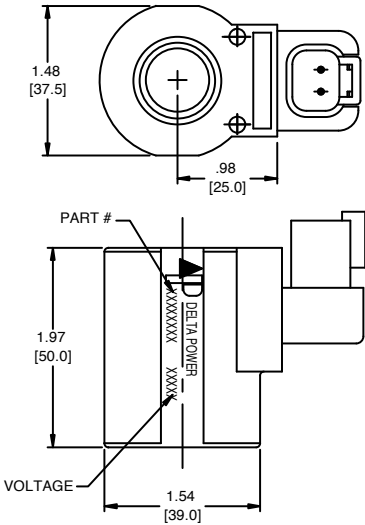

ORDERING INFORMATION

	L	-	-	
TERMINATIONS				
AMP Superseal - Integral	IA		12	
Deutsch - Integral DT04-2P	ID		24	
AMP Junior Timer - Integral	IJ			
Metri-Pack - Integral	IM			

VOLTAGE	
12 VDC / 2.2 Amp Yellow Lettering	
24 VDC / 1.1 Amp Blue Lettering	

Approximate Coil Weight: .49 lbs (.22 kg)

NOTE: Pull type valves require nut 36202073 in lieu of standard nut. Push type valves require nut 36202071 in lieu of standard nut.

WARNING: the specifications/application data shown in our catalogs and data sheets are intended only as a general guide for the product described (herein). Any specific application should not be undertaken without independent study, evaluation, and testing for suitability.



4484 Boeing Drive Rockford, IL 61109 • USA • Phone +1 (815) 397-6628 • Fax +1 (815) 397-2526
 mail: delta@delta-power.com • www.delta-power.com



Via Malavolti, 36 • 41122 Modena • ITALY • Phone +39 (059) 254895 • Fax +39 (059) 253512
 mail: tecnord@tecnord.com • www.tecnord.com