

DE-CVA DIRECT ACTING CHECK VALVE, POPPET

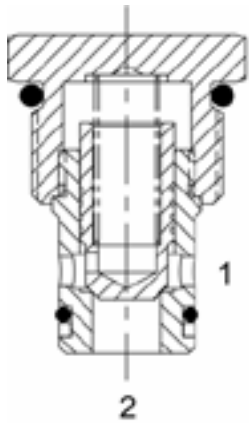

DESCRIPTION

10 size, 7/8-14 thread, "Delta" series, direct acting check valve.

OPERATION

The DE-CVA allows free flow passage from (2) to (1), and blocks flow from (1) to (2). The cartridge has a fully guided check poppet, which is spring-biased closed, until sufficient pressure is applied at (2) to open to (1).

FEATURES

- Hardened parts for long life and low leakage.
- Optional bias springs for backpressure application flexibility.
- Fully guided poppet assembly.
- Industry common cavity.

HYDRAULIC SYMBOL

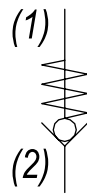

Drop-In pilot pistons can be used (except the 135 and 150 PSI version) to create P.O. Check Valve Function, see the Hydraulic Integrated Circuits section for details.

PERFORMANCE

Actual Test Data (Cartridge Only)

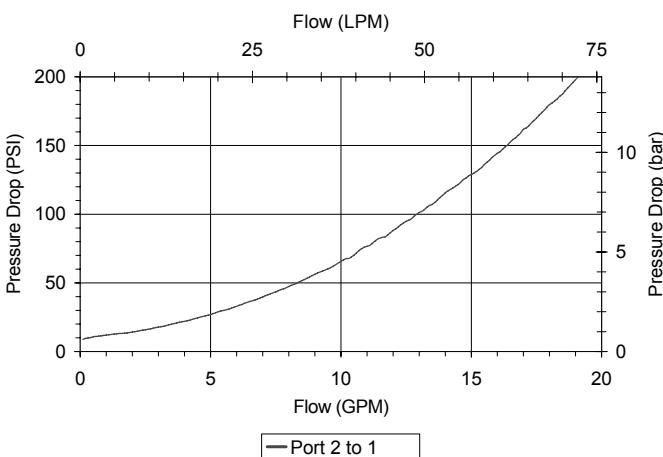

VALVE SPECIFICATIONS

Nominal Flow	15 GPM (57 LPM)
Rated Operating Pressure	3500 PSI (241 bar)
Typical Internal Leakage (150 SSU)	0-5 drops/min
Viscosity Range	36 to 3000 SSU (3 to 647 cSt)
Filtration	ISO 18/16/13
Media Operating Temp. Range	-40° to 250°F (-40° to 120°C)
Weight	.15 lbs (.07 kg)
Operating Fluid Media	General Purpose Hydraulic Fluid
Cartridge Torque Requirements	30 ft-lbs (40.6 Nm)
Cavity	DELTA 2W
Cavity Form Tool (Finishing)	40500000
Seal Kit	21191200

WARNING: the specifications/application data shown in our catalogs and data sheets are intended only as a general guide for the product described (herein). Any specific application should not be undertaken without independent study, evaluation, and testing for suitability.



4484 Boeing Drive Rockford, IL 61109 • USA • Phone +1 (815) 397-6628 • Fax +1 (815) 397-2526
 mail: delta@delta-power.com • www.delta-power.com



Via Malavolti, 36 • 41122 Modena • ITALY • Phone +39 (059) 254895 • Fax +39 (059) 253512
 mail: tecnord@tecnord.com • www.tecnord.com

DIMENSIONS

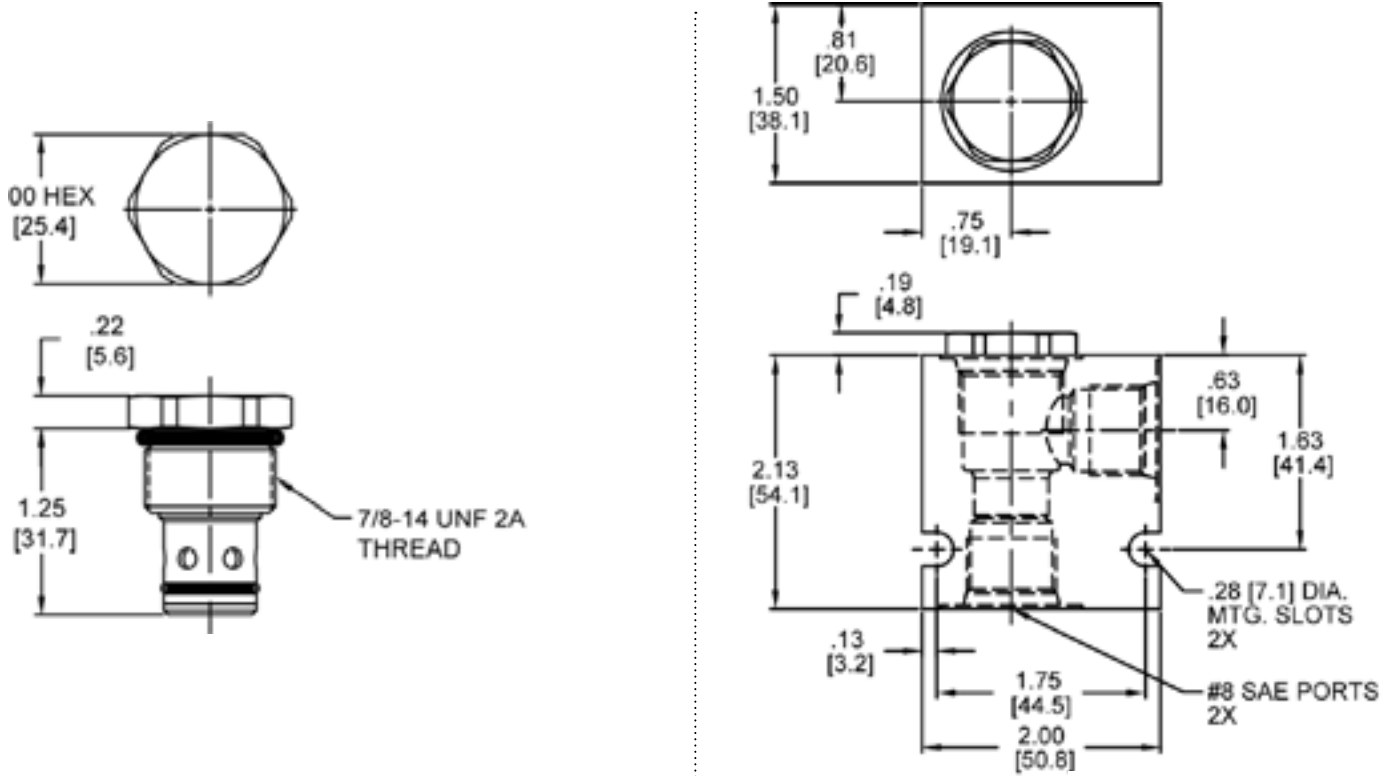

Body Weight: .47 lbs (.21 kg)

ORDERING INFORMATION

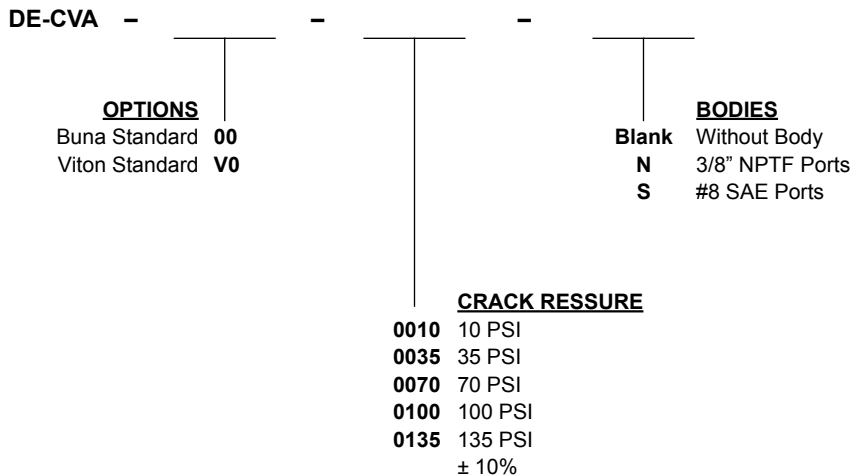

W 40 / 2018

WARNING: the specifications/application data shown in our catalogs and data sheets are intended only as a general guide for the product described (herein). Any specific application should not be undertaken without independent study, evaluation, and testing for suitability.



4484 Boeing Drive Rockford, IL 61109 • USA • Phone +1 (815) 397-6628 • Fax +1 (815) 397-2526
 mail: delta@delta-power.com • www.delta-power.com



Via Malavolti, 36 • 41122 Modena • ITALY • Phone +39 (059) 254895 • Fax +39 (059) 253512
 mail: tecnord@tecnord.com • www.tecnord.com