

**HR MULTI-FUNCTION ERGONOMIC RIGHT HAND GRIP**

**FEATURES**

- Optimum ergonomic design.
- High performance switches.

**MECHANICAL SPECIFICATIONS**

Material:	thermoplastic
Colour:	black
Operating temperature range:	-25°C / +85°C
Protection class:	IP 65 with plain grip (IP 67 with special assembly on request)
Connecting hub:	female thread / M14 x 1.5

**ELECTRICAL SPECIFICATIONS**

Prewired exit cable: 250 mm

**Available push buttons and switches**

C - Dead man capacitive switch SPST contact, Normally Open Contact rating 1A	
DFF - Rocker Switch:	see page JK60 Technical Info
K1 - Rocker Switch:	see page JK60 Technical Info
P9 - P9L - Push buttons:	see page JK61 Technical Info
FPR - Proportional roller:	see FPR data sheet
Output signal:	3-pins connection hall effect contactless sensor

**OVERALL DIMENSIONS**

Mod.  
HR/1FPR-2P9/R000

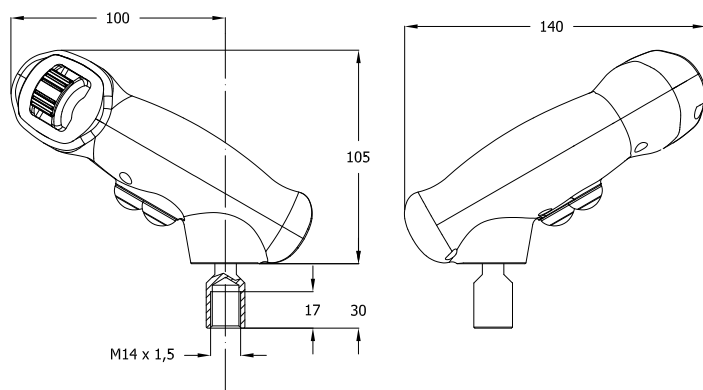

**HR ORDERING INFORMATION:** see page JK40



FRONT VIEW - RIGHT HAND

**CONFIGURATION EXAMPLES**

	FRONT P/B	BOTTOM P/B	REAR P/B
HR/0000-000/R000	0	0	0
HR/01P9-000/R000	1xP9	0	0
HR/02P9-000/R000	2xP9	0	0
HR/03P9-000/R000	3xP9	0	0
HR/04P9-000/R000	4xP9	0	0
HR/04P9-1P9/R000	4xP9	1xP9	0
HR/04P9-2P9/R000	4xP9	2xP9	0
HR/04P9-2P9/R1P9	4xP9	2xP9	1xP9
HR/04P9-2P9/R2P9	4xP9	2xP9	2xP9
HR/0FPR-000/R000	1xFPR	0	0
HR/0000-000/RFPR	0	0	1xFPR
HR/0FPR-000/RFPR	1xFPR	0	1xFPR
HR/01K1-000/R000	1xK1	0	0
HR/0000-000/R1K1	0	0	1xK1
HR/01K1-000/R1K1	1xK1	0	1xK1
HR/0DFF-000/R000	1xDFF	0	0
HR/0000-000/RDFF	0	0	1xDFF
HR/0DFF-000/RDFF	1xDFF	0	1xDFF

W 3 / 2021

**WARNING:** the specifications/application data shown in our catalogs and data sheets are intended only as a general guide for the product described (herein). Any specific application should not be undertaken without independent study, evaluation, and testing for suitability.



4484 Boeing Drive Rockford, IL 61109 • USA • Phone +1 (815) 397-6628 • Fax +1 (815) 397-2526  
mail: delta@delta-power.com • www.delta-power.com



Via Malavolti, 36 • 41122 Modena • ITALY • Phone +39 (059) 254895 • Fax +39 (059) 253512  
mail: tecnord@tecnord.com • www.tecnord.com

**HR MULTI-FUNCTION ERGONOMIC RIGHT HAND GRIP**

**FEATURES**

- Optimum ergonomic design.
- High performance switches.

**MECHANICAL SPECIFICATIONS**

Material:	thermoplastic
Colour:	black
Operating temperature range:	-25°C / +85°C
Protection class:	IP 65 with plain grip (IP 67 with special assembly on request)
Connecting hub:	female thread / M14 x 1.5

**ELECTRICAL SPECIFICATIONS**

Prewired exit cable:	250 mm
----------------------	--------

**Available push buttons and switches**

C - Dead man capacitive switch SPST contact, Normally Open Contact rating 1A	
DFF - Rocker Switch:	see page JK60 Technical Info
K1 - Rocker Switch:	see page JK60 Technical Info
P9 - P9L - Push buttons:	see page JK61 Technical Info
FPR - Proportional roller:	see FPR data sheet
Output signal:	3-pins connection hall effect contactless sensor

**OVERALL DIMENSIONS**

Mod.  
HR/1FPR-2P9/R000

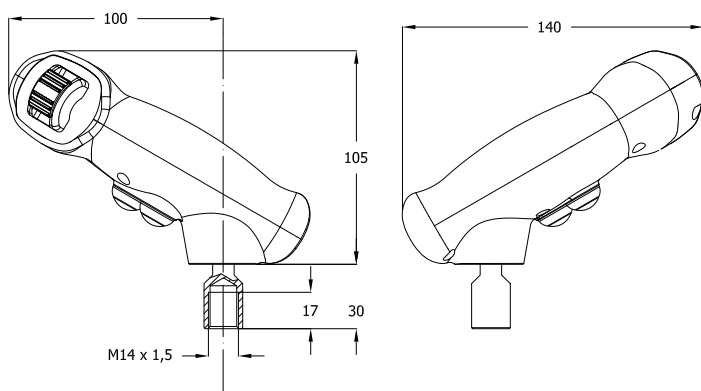

REAR VIEW - RIGHT HAND

**CONFIGURATION EXAMPLES**

	FRONT P/B	BOTTOM P/B	REAR P/B
HR/0000-000/R000	0	0	0
HR/0FPR-000/R000	1xFPR	0	0
HR/0FPR-1P9/R000	1xFPR	1xP9	0
HR/0FPR-2P9/R000	1xFPR	2xP9	0
HR/0FPR-2P9/R1P9	1xFPR	2xP9	1xP9
HR/0FPR-2P9/R2P9	1xFPR	2xP9	2xP9
HR/0FPR-000/R1FPR	1xFPR	0	1xFPR
HR/0FPR-1P9/R1FPR	1xFPR	1xP9	1xFPR
HR/0FPR-2P9/R1FPR	1xFPR	2xP9	1xFPR

HR ORDERING INFORMATION: see page JK40

**WARNING:** the specifications/application data shown in our catalogs and data sheets are intended only as a general guide for the product described (herein). Any specific application should not be undertaken without independent study, evaluation, and testing for suitability.



4484 Boeing Drive Rockford, IL 61109 • USA • Phone +1 (815) 397-6628 • Fax +1 (815) 397-2526  
mail: delta@delta-power.com • www.delta-power.com



Via Malavolti, 36 • 41122 Modena • ITALY • Phone +39 (059) 254895 • Fax +39 (059) 253512  
mail: tecnord@tecnord.com • www.tecnord.com